

DRAFT COPY

DO NOT SCALE. IF IN DOUBT ASK!

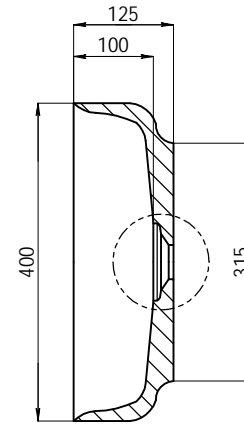

SECTION B-B

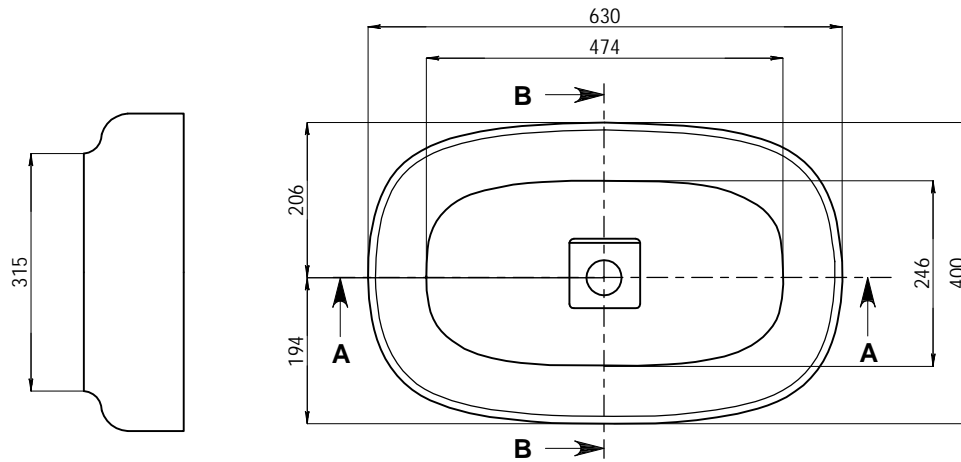
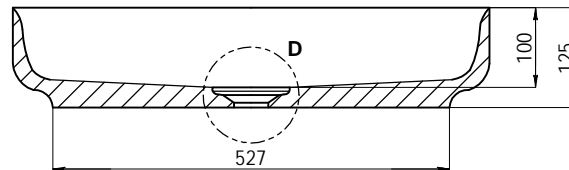
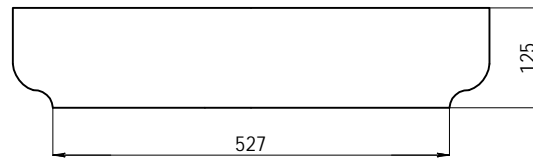
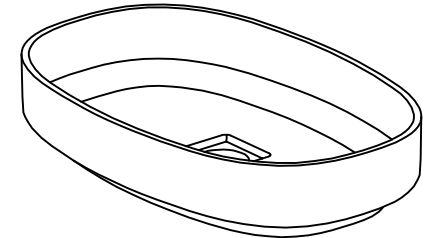

SECTION A-A

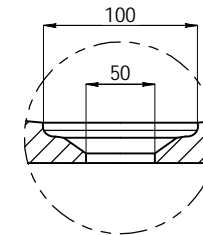

DETAIL D
SCALE 1:2

COLOUR
QTY
APPROVED BY:
NAME & SIGNATURE
DATE APPROVED:

- NOTES
- ALL INTERNAL CORNERS TO BE R5 UNLESS OTHERWISE STATED.
 - BASINS IN AUSTRALIA COME WITH GLOSS FINISH ONLY ON SPECIAL ORDER - 8 WEEKS DELAY (SURCHARGE APPLIES). ALL BASINS DO NOT COME WITH A WASTE FITTING.

COPYRIGHT © APPLIES. DUPLICATION OF THIS DRAWING OR ANY SPECIFIC DESIGN FEATURES IS NOT PERMITTED WITHOUT WRITTEN AUTHORITY. "COMMERCIAL CONFIDENTIALITY" IS ASSUMED AND REQUIRED.

UNLESS OTHERWISE STATED ALL DIMENSIONS IN MILLIMETERS	MATERIAL:	KASKADE STONE	DRAWING NUMBER	BONN-630	SCALE 1:1	A4
	FINISH:	REFER TO ORDER			SHEET 1 OF 1	REV. 1
DRAWING LEGEND	N.W	12 kg	Product Size	630X400X125	 KASKADE STONE www.kaskadebaths.de	
	G.W	kg	Package size			
LINEAR / ANGULAR TOLERANCES	DRAWN	KASKADE	DATE	02/03/15		
No Decimals 1 Decimal 2 Decimals	CHK'D		DATE			
		±5		±3°		

REV	DESCRIPTION	DWG	DATE	CHK'D	DATE
1	RELEASE DATE.	KASKADE	02/03/15		